

*Range*  
—  
**VELVET**



---

**PRICELIST**

OVH-HINNASTO (SIS. ALV. 24%) – EURO

---

**FINLAND**

01.01.2024



## Range

# VELVET

VELVET is a modern range with a retro look. The modern idiom is complemented by beautiful handcrafted details throughout the entire range – an ode to the old crafting techniques.

### Designed by

Cecilie Kamp



### This range include

Dining tables | Coffee tables  
Sideboards | HIFI sideboards  
Cabinets | Benches  
Shelf furniture | Desks  
Pedestals | Bedside tables

## Features



### Design elements

Choose between different designs on plates, legs and edgeprofiles.



### Custommade

In addition to our many standard sizes we can accommodate special requests.



### Wood colours

Choose between more than 10+ different wood colours in both ash and oak.



### Sustainable choice

Solid wood furniture can last a lifetime with proper maintenance

## Social media

Follow and share with us on Instagram.



@kristensenfurniture | #kristensenfurniture

## Pricelist- and imagebank

On our Collection-site you as a retailer always have access to the latest pricelists and hundreds of high resolution images and videos - **Free to use in your marketing!**

If you do not have a password yet, please contact the Kristensen sales office in Denmark.

### LINK:

[collection.kristensen.com](https://collection.kristensen.com)

# PRICELIST

## Round Dining Table (undivided)

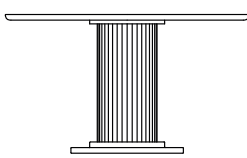

Round Column dining table w/undivided plate (H: 74 cm, plate 3 cm)			
description	item no.	Price (EUR)	
		Ash	Oak
 Undivided	VE3H-160	<b>2.409</b>	<b>3.011</b>
	VE3H-140	<b>2.036</b>	<b>2.546</b>
	VE3H-130	<b>1.807</b>	<b>2.259</b>
	VE3H-120	<b>1.704</b>	<b>2.130</b>
	VE3H-100	<b>1.658</b>	<b>2.073</b>

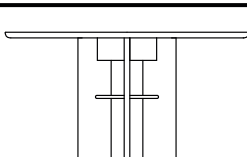
Round Fan dining table w/brass or black pipes (undivided plate) (H: 74 cm, plate 3 cm)			
description	item no.	Price (EUR)	
		Ash	Oak
 Undivided	FA3H-160	<b>2.531</b>	<b>3.164</b>
	FA3H-140	<b>2.267</b>	<b>2.833</b>
	FA3H-130	<b>2.032</b>	<b>2.540</b>
	FA3H-120	<b>1.997</b>	<b>2.497</b>
	FA3H-100	<b>1.804</b>	<b>2.255</b>



The Velvet FAN tables can be made with a brass pipe or a black steel pipe.

# PRICELIST

Round Dining Table (extendable for 4 leaves)

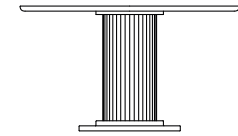

Round Column dining table w/middle extension (H: 74 cm, plate 3 cm)			
description	item no.	Price (EUR)	
		Ash	Oak
 Extendable	VE3M-160*	<b>2.647</b>	<b>3.309</b>
	VE3M-140*	<b>2.263</b>	<b>2.828</b>
	VE3M-130*	<b>1.988</b>	<b>2.485</b>
	VE3M-120*	<b>1.894</b>	<b>2.367</b>
	VE3M-100**	<b>1.824</b>	<b>2.280</b>

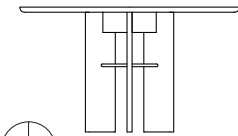
Round Fan dining table w/brass or black pipes & middle extension (H: 74 cm, plate 3 cm)			
description	item no.	Price (EUR)	
		Ash	Oak
 Extendable	FA3M-160*	<b>2.775</b>	<b>3.469</b>
	FA3M-140*	<b>2.516</b>	<b>3.145</b>
	FA3M-130*	<b>2.196</b>	<b>2.745</b>
	FA3M-120*	<b>2.128</b>	<b>2.660</b>

Leaves - for tables w/middle extension			
description	item no.	Price (EUR)	
		Ash	Oak
leaf 45x160 cm	VET3-160	<b>387</b>	<b>484</b>
leaf 45x140 cm	VET3-140	<b>366</b>	<b>458</b>
leaf 45x130 cm	VET3-130	<b>347</b>	<b>433</b>
leaf 45x120 cm	VET3-120	<b>328</b>	<b>409</b>
leaf 45x100 cm	VET3-100	<b>288</b>	<b>360</b>

\* Comes with 2 support legs

\*\* Comes with 1 support leg

The Velvet FAN tables can be made with a brass pipe or a black steel pipe.

# PRICELIST

## Oblong Dining Table (undivided)



**plate 10**



R10 top plate: here the legs will always be mounted 23 cm from the table end.

Extension leaf R5.

**plate 45**



R45 table top: here the legs will always be mounted 33 cm from the table end.

### Dining table w/steel legs & undivided plate (H: 74 cm, plate 3 cm)

description + drawing	item no.	dimensions (cm)	Price (EUR)	
			Ash	Oak
<p>Pillar leg + plate 10 / 45</p>	VEC3H-260	260x90	<b>3.247</b>	<b>4.059</b>
	VEC3H-240	240x90	<b>3.021</b>	<b>3.776</b>
	VEC3H-220	220x90	<b>2.885</b>	<b>3.606</b>
	VEC3H-200	200x90	<b>2.772</b>	<b>3.465</b>
	VEC3H-180	180x90	<b>2.659</b>	<b>3.323</b>
<p>Ribbed leg + plate 10 / 45</p>	VER3H-260	260x90	<b>2.625</b>	<b>3.281</b>
	VER3H-240	240x90	<b>2.370</b>	<b>2.963</b>
	VER3H-220	220x90	<b>2.240</b>	<b>2.800</b>
	VER3H-200	200x90	<b>2.116</b>	<b>2.645</b>
	VER3H-180	180x90	<b>1.997</b>	<b>2.496</b>

### End leaves for Ø10 table - for tables w/undivided plate

description	item no.	dimensions (cm)	Price (EUR)	
			Ash	Oak
Leaf	VET3H-90	90x50	<b>362</b>	<b>453</b>

# PRICELIST

## Bench

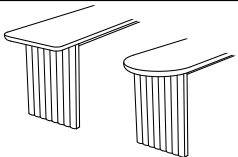

Dining bench (H: 45 cm, plate 3 cm)				
description + drawing	item no.	dimensions (cm)	Price (EUR)	
			Ash	Oak
 Ribbed leg + plate 10 / 45	VEBER3-240	240x35 cm	<b>1.116</b>	<b>1.395</b>
	VEBER3-220	220x35 cm	<b>997</b>	<b>1.247</b>
	VEBER3-200	200x35 cm	<b>950</b>	<b>1.188</b>
	VEBER3-180	180x35 cm	<b>903</b>	<b>1.129</b>

# PRICELIST

## Sideboard



### Handles



**M**  
Brass



**B**  
Black steel

### Additional information

#### Soft close

Alle doors (except the hidden doors in the ends) are with soft close.

Sideboard							
Drawing	Leg type	Item no.	dimensions (cm)			price (EUR)	
			W	D	H	Ash	Oak
 Sideboard w/3 doors (+2 hidden) extra height	H40 cm steel legs	VE3DH	185	46	90	<b>3.035</b>	<b>3.794</b>
	H40 cm wooden legs*	VE3DHW				<b>3.163</b>	<b>3.972</b>
 Sideboard w/2 doors (+2 hidden) extra height	H40 cm steel legs	VE2DH	139	46	90	<b>2.631</b>	<b>3.289</b>
	H40 cm wooden legs*	VE2DHW				<b>2.733</b>	<b>3.442</b>
 Sideboard w/3 doors (+2 hidden)	H30 cm steel legs	VE3D	185	46	80	<b>2.891</b>	<b>3.614</b>
	H30 cm wooden legs*	VE3DW				<b>3.018</b>	<b>3.792</b>
 Sideboard w/2 doors (+2 hidden)	H30 cm steel legs	VE2D	139	46	80	<b>2.506</b>	<b>3.132</b>
	H30 cm wooden legs*	VE2DW				<b>2.608</b>	<b>3.285</b>

\*Wooden legs with brass or black steel pipe.

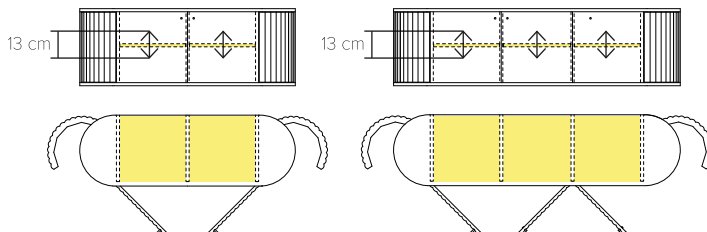

These are made in standard sizes only!

All prices are retail prices (including VAT 24%) in Euro. We accept no liability for any errors or omissions.

# PRICELIST

## HIFI Sideboard



### Handles



**M**  
Brass





**B**  
Black steel

### Additional information

#### Soft close

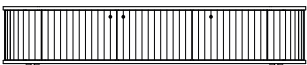
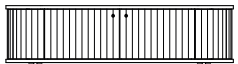
Alle doors (except the hidden doors in the ends) are with soft close.

HIFI sideboard							
description	Leg type	item no.	dimensions (cm)			price (EUR)	
			W	D	H	Ash	Oak
 sideboard w/3 doors (+2 hidden). With holes for wires in the back.	H20 cm steel legs	VE3DL	185	46	55	<b>2.489</b>	<b>3.111</b>
	H20 cm wooden legs*	VE3DLW	185	46	55	<b>2.616</b>	<b>3.289</b>
 sideboard w/2 doors (+2 hidden). With holes for wires in the back.	H20 cm steel legs	VE2DL	139	46	55	<b>2.053</b>	<b>2.567</b>
	H20 cm wooden legs*	VE2DLW	139	46	55	<b>2.155</b>	<b>2.719</b>
 sideboard w/3 doors (+2 hidden). Hole for wires in top (plug) and the back.	H20 cm steel legs	VE3DLK	185	46	55	<b>2.489</b>	<b>3.111</b>
	H20 cm wooden legs*	VE3DLKW	185	46	55	<b>2.616</b>	<b>3.289</b>
 sideboard w/2 doors (+2 hidden). Hole for wires in top (plug) and the back.	H20 cm steel legs	VE2DLK	139	46	55	<b>2.053</b>	<b>2.567</b>
	H20 cm wooden legs*	VE2DLKW	139	46	55	<b>2.155</b>	<b>2.719</b>

\*Wooden legs with brass or black steel pipe.

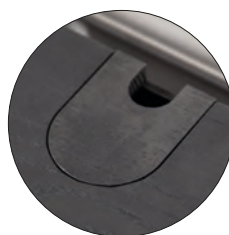

#### VE3DLK / VE2DLK

These variants are with a wooden plug/hole for wires centered in the top, against the wall.

These are made in standard sizes only!

All prices are retail prices (including VAT 24%) in Euro.  
 We accept no liability for any errors or omissions.



# PRICELIST

## Vitrine





VEG3D & VEW2D is w/fluted sides.  
VEG4D wi w/smooth sides, but with 2 fluted doors.

### Additional information

**Soft close**  
All doors are with soft close.

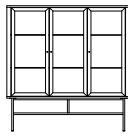
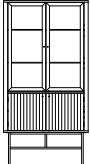
**Tempered glass**  
We use tempered glass on our vitrines

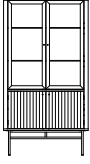
Vitrine							
Drawing	Leg type	Item no.	dimensions (cm)			price (EUR)	
			W	D	H	Ash	Oak
 w/3 glass doors & fluted sides.	H40 cm steel legs	VEG3DH	150	42	152	<b>3.219</b>	<b>3.702</b>
	H40 cm wooden legs*	VEG3DHW				<b>3.346</b>	<b>3.879</b>
 w/2 glass & 2 fluted wooden doors (smooth sides)	H40 cm steel legs	VEG4DH	103	42	200	<b>3.496</b>	<b>4.020</b>
	H40 cm wooden legs*	VEG4DHW				<b>3.598</b>	<b>4.173</b>
 w/3 glass doors & fluted sides.	H30 cm steel legs	VEG3D	150	42	142	<b>3.207</b>	<b>3.689</b>
	H30 cm wooden legs*	VEG3DW				<b>3.334</b>	<b>3.866</b>
 w/2 glass & 2 fluted wooden doors (smooth sides)	H30 cm steel legs	VEG4D	103	42	190	<b>3.485</b>	<b>4.007</b>
	H30 cm wooden legs*	VEG4DW				<b>3.586</b>	<b>4.160</b>

\*Wooden legs with brass or black steel pipe.



### Handles

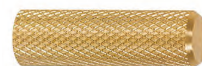

**M**  
Brass



**B**  
Black steel

These are made in standard sizes only!

All prices are purchase prices in Euro.  
We accept no liability for any errors or omissions.

# PRICELIST

## Coffee Table

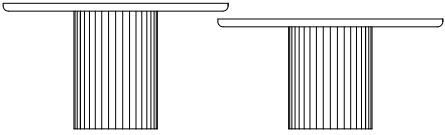
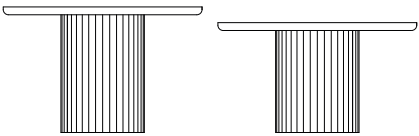
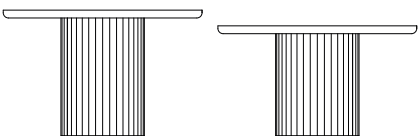
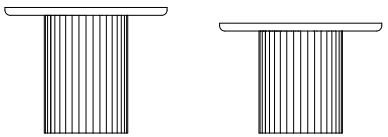

Coffee table ( plate thickness 3 cm )					
description	item no.	dimensions (cm)		price (EUR)	
		Ø	H	Ash	Oak
 Round coffee table w/ribbled column leg.	VECO-86x48	86	48	<b>1.020</b>	<b>1.276</b>
	VECO-86x42	86	42	<b>983</b>	<b>1.229</b>
 Round coffee table w/ribbled column leg.	VECO-76x48	76	48	<b>928</b>	<b>1.160</b>
	VECO-76x42	76	42	<b>894</b>	<b>1.117</b>
 Round coffee table w/ribbled column leg.	VECO-62x48	62	48	<b>809</b>	<b>1.011</b>
	VECO-62x42	62	42	<b>775</b>	<b>969</b>
 Round coffee table w/ribbled column leg.	VECO-48x48	48	48	<b>701</b>	<b>877</b>
	VECO-48x42	48	42	<b>673</b>	<b>841</b>





These are made in standard sizes only!

All prices are retail prices (including VAT 24%) in Euro.  
We accept no liability for any errors or omissions.

# PRICELIST

## Coffee Table w/glass & storage



Coffee table w/glass top & storage room ( glass plate thickness 6 mm )						
description	item no.	dimensions (cm)		price (EUR)		
		Ø	H	Ash	Oak	
 w/glass top and 1-door storage room.	VECSGL-100x52	100	52	<b>1.094</b>	<b>1.368</b>	
	VECSGL-100x46	100	46	<b>1.067</b>	<b>1.334</b>	
 w/glass top and 1-door storage room.	VECSGL-90x52	90	52	<b>1.078</b>	<b>1.348</b>	
	VECSGL-90x46	90	46	<b>1.051</b>	<b>1.314</b>	
 w/glass top and 1-door storage room.	VECSGL-80x52	80	52	<b>1.057</b>	<b>1.321</b>	
	VECSGL-80x46	80	46	<b>1.030</b>	<b>1.287</b>	
 1-door storage (w/no glass plate)	VECSL*/R**-48x51	48	51	<b>950</b>	<b>1.187</b>	
	VECSL*/R**-48x45	48	45	<b>923</b>	<b>1.154</b>	

\*L = left hanged door. \*\*R = right hanged door.

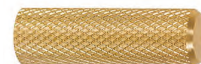

**M**  
Brass



**B**  
Black steel

These are made in standard sizes only!

All prices are retail prices (including VAT 24%) in Euro.  
We accept no liability for any errors or omissions.

# PRICELIST

## Fan Pedestal

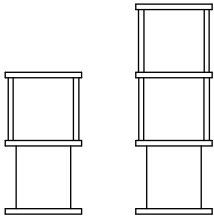
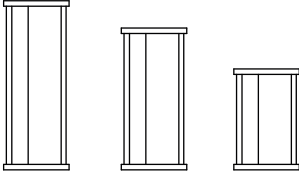

Fan pedestals / flower- or side table						
description	item no.	dimensions (cm)			price (EUR)	
		W	D	H	Ash	Oak
 w/2-3 shelves & pipe*.	FAPE-28x77	28	28	77	<b>401</b>	<b>482</b>
	FAPE-28x52	28	28	52	<b>375</b>	<b>449</b>
 pedestal w/pipe*.	FAPE-24x62	24	24	62	<b>294</b>	<b>353</b>
	FAPE-24x52	24	24	52	<b>281</b>	<b>337</b>
	FAPE-24x37	24	24	37	<b>268</b>	<b>321</b>

\*Brass or black steel pipe.







These are made in standard sizes only!

All prices are retail prices (including VAT 24%) in Euro.  
We accept no liability for any errors or omissions.

# PRICELIST

## Shelving Unit

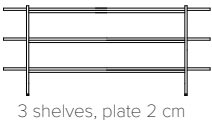

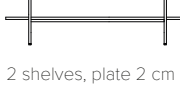
Shelving unit						
description	item no.	dimensions (cm)			price (EUR)	
		W	D	H	Ash	Oak
 <p>4 shelves, plate 2 cm</p>	VEB-180x104	180	45	104(102)	<b>1.810</b>	<b>2.263</b>
 <p>4 shelves, plate 2 cm</p>	VEB-160x104	160	45	104(102)	<b>1.725</b>	<b>2.157</b>
 <p>3 shelves, plate 2 cm</p>	VEB-180x78	180	45	78(76)	<b>1.420</b>	<b>1.775</b>
 <p>3 shelves, plate 2 cm</p>	VEB-160x78	160	45	78(76)	<b>1.352</b>	<b>1.690</b>
 <p>2 shelves, plate 2 cm</p>	VEB-180x52	180	45	52(50)	<b>1.109</b>	<b>1.386</b>
 <p>2 shelves, plate 2 cm</p>	VEB-160x52	160	45	52(50)	<b>1.058</b>	<b>1.322</b>

*These are only available with straight edges!*

# PRICELIST

## Desk



Desk						
description	item no.	measures (cm)			price (EUR)	
		L	D	H	Ash	Oak
Desk with 2 storage rooms. With wire holes and laptop "shelf".	VED-185x65	185	65	74	<b>2.400</b>	<b>3.150</b>
Desk with 2 storage rooms. With wire holes.	VED-169x54	169	54	74	<b>2.144</b>	<b>2.814</b>

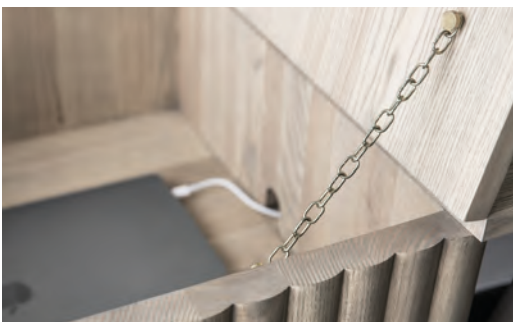

### WIRES

All desks are made with holes for leading wires in a nice way.



### VED-185x65

This variant is with a "shelf" for your laptop. This can make the air circulate around the computer.

*These are made in standard sizes only!*

*All prices are retail prices (including VAT 24%) in Euro. We accept no liability for any errors or omissions.*

# PRICELIST

## Night Stands

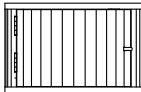
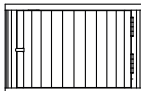
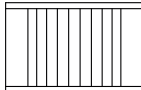

Wall storage ( nightstands )						
description	item no.	dimensions (cm)			price (EUR)	
		W	D	H	Ash	Oak
 w/1 left hanged door	VEWA-1LD30	46	25	30	<b>762</b>	<b>953</b>
 w/1 righthanged door	VEWA-1RD30	46	25	30	<b>762</b>	<b>953</b>
 w/1 room	VEWA-1RO30	46	25	30	<b>468</b>	<b>585</b>

### Handles



**M**  
Brass



**B**  
Black steel

*These are made in standard sizes only!*

*All prices are retail prices (including VAT 24%) in Euro.  
We accept no liability for any errors or omissions.*



**Images for guiding purpose only!**

The wood structure and colour will vary from ash and oak.

We therefore recommend using the wood samples/exhibition furniture to get a more accurate impression.

# WOOD COLOURS

---



**ASH C3 / OAK C3**  
Lacquered

We treated this wood with lacque.

**C3 are only made for products without patination.**



**ASH C4 / OAK C4**  
Natural oiled

We treated this wood with our 'Natural oil'.



**ASH C6 / OAK C6**  
White oiled

We treated this wood with our 'White oil'.



**ASH C8 / OAK C8**  
Soaped

We treated this wood with soap.

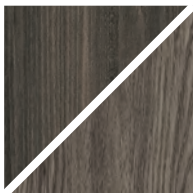

**ASH C11 / OAK C11**  
Dark grey oiled

We treated this wood with our 'Black oil'.



**ASH C12 / OAK C12**  
Antique brown oiled

We treated this wood with our 'Antique brown oil'.



**ASH C13 / OAK C13**  
Light grey oiled

We treated this wood with our 'Light grey oil'.



**ASH C14 / OAK C14**  
Black stained & oiled

We treated this wood with black stain, and treated it with a wax oil.

**C14 is for legs and storage furniture only!**



**ASH C15 / OAK C15**  
Mocca brown oiled

We treated this wood with our 'Mocca brown oil'.

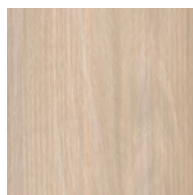

**ASH C16**  
Warm white oiled

We treated this wood with our 'Warm white oil'.

**C16 is only for ash**



**ASH C20 / OAK C20**  
Grey brown oiled

We treated this wood with our 'Grey brown oil'.



**ASH C44 / OAK C44**  
Black matt lacquered

We treated this wood with black stain, and treated it with matt lacque.

**C44 is only for plates and can only be made for products without patination.**



For more information about maintenance, please visit our website:  
[WWW.KRISTENSEN.COM](http://WWW.KRISTENSEN.COM)



We also offers our own repairoils for our products  
- contact us if you need a pricelist.



## WOOD FINISH

---



### UP

#### Without patination

The wood is planned and sanded to achieve a smooth surface.

*With few and smaller knots.*

**Storage furniture can only be made with this finish!**



### SC

#### Soft Cracks

Naturally occurring cracks are made more visible which gives a rustic look with cracks in the surface.

*May contain more and larger knots.*



### RL

#### Raw Look

We brush off the layer of softer wood which gives a look of wood that has been roughened by natural wear.

*May contain more and larger knots.*

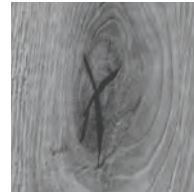

### FK

#### Filled Knots

The knots are filled and the wood is planned and sanded to achieve a smooth surface.

**Only for OAK!**

## METAL COLOUR & FINISH

---



**Industrial steel**

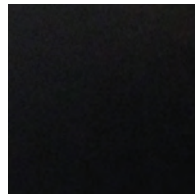

**Black matt steel**

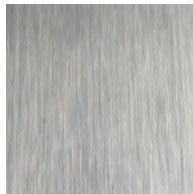

**Brushed stainless steel**

**Additional +10%**

# INFO

## Velvet oblong dining tables

### Edge profiles



#1 - Harlekin



#2 - Arched



#3 - Rounded  
(Pisa)



#4 - Straight



plate 10

R10 top plate: here the legs will always be mounted 23 cm from the table end.

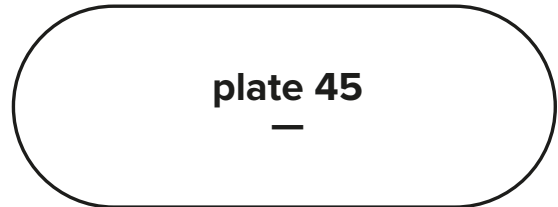
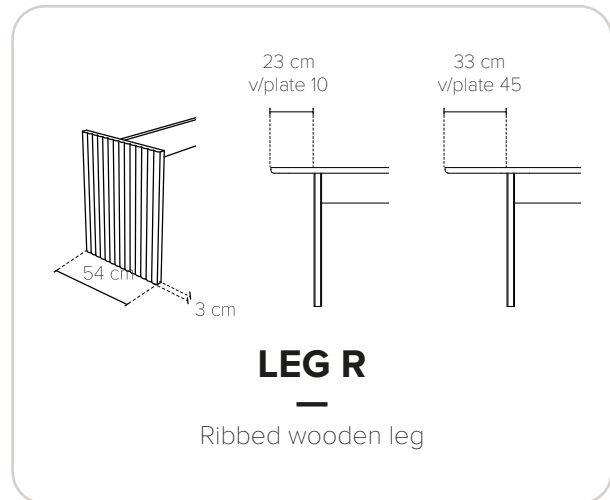
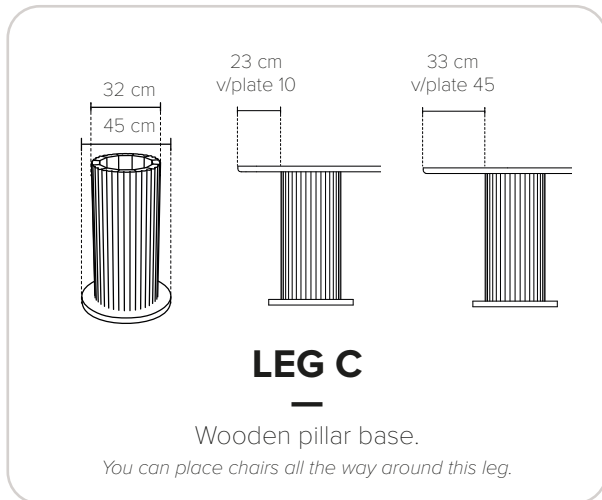

plate 45

R45 table top: here the legs will always be mounted 33 cm from the table end.



# INFO

## Velvet round dining tables

### Edge profiles

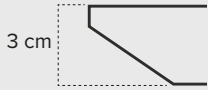

#1 - Harlekin



#2 - Arched



#3 - Rounded  
(Pisa)



#4 - Straight

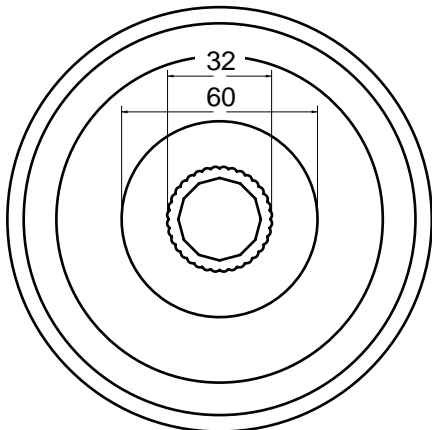
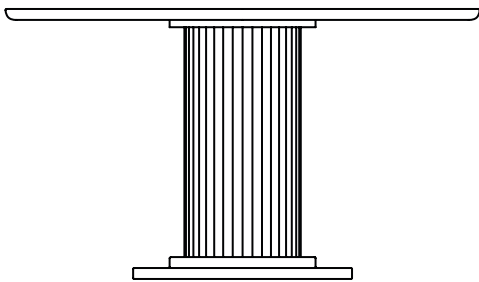

D100-130 cm

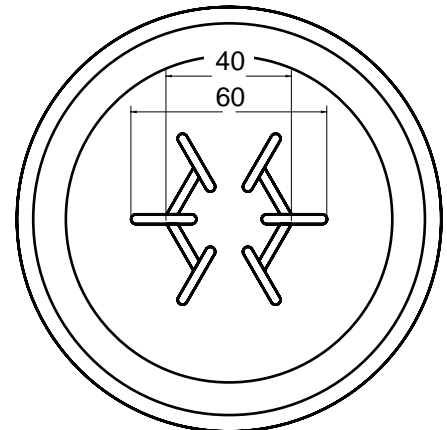
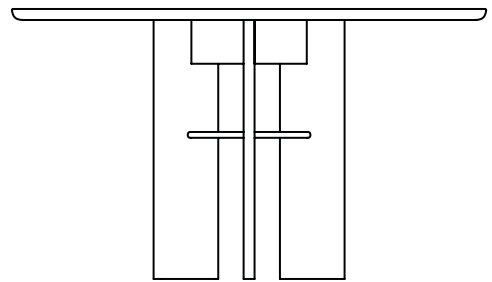

D100-130 cm

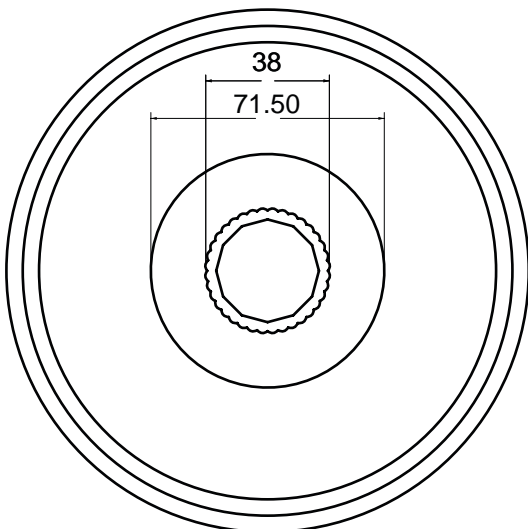

D140-160 cm

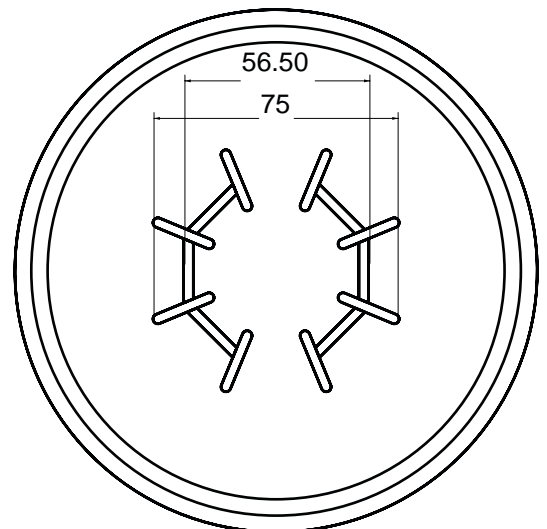

D140-160 cm

# OTA YHTEYTTÄ

## MITTATILAUSPÖYDÄT

Voimme tehdä kaikkia pöytämallejimme mittojen mukaan. Mittatilaustuotteet vaativat erikoiskäsittelyä: materiaalin käsittelyä, uusia piirroksia, työstökoneiden asetusten kohdentamista sekä tuotteiden paketoitua. Tästä johtuen mittatilaustuotteisiin lisätään aina erikoistyölisä, oli tuote suurempi tai pienempi kuin standardikoko. Jos esimerkiksi haluat pöydän pienempänä, lisätään lähimpää kokoa olevan tuotteen hintaan erikoistyölisä +15%.

*Olen meihin yhteydessä lisätietoja saadaksesi!*

### Head office, Denmark

**OSOITE:**

Kristensen & Kristensen A/S  
Storstrømsvej 44  
6715 Esbjerg N  
DK - Denmark

**PUHELIN:**

+45 75470303

**FAX:**

+45 75470304

**KOTISIVU:**

[www.kristensen.com](http://www.kristensen.com)

**MAIL:**

[kristensen@kristensen.dk](mailto:kristensen@kristensen.dk)

**TILAUKSET:**

[order@kristensen.dk](mailto:order@kristensen.dk)

**REKLAMAATIOT:**

[claim@kristensen.dk](mailto:claim@kristensen.dk)

### Edustaja Suomessa

Jokko Salmevaara

—

✉ [jokko.salmevaara@boknas.fi](mailto:jokko.salmevaara@boknas.fi)

☎ +358 040 195 8886