

# EMILY

## TECHNICAL SPECIFICATION

### PROFILE

COMFORT: standard

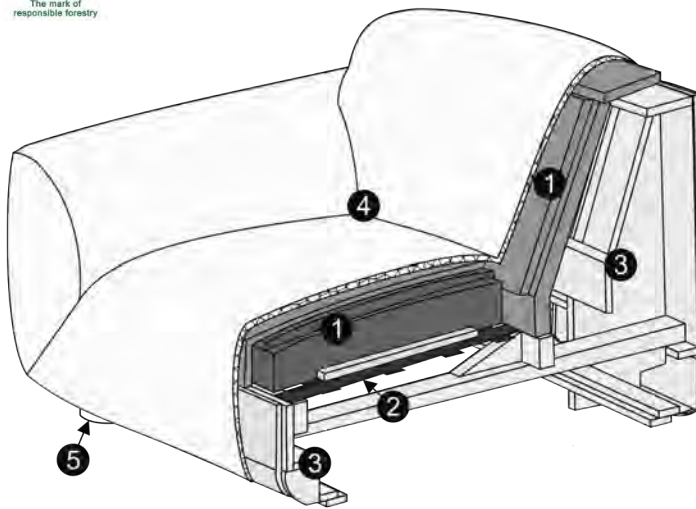

- |   |   |
|---|---|
| 1 | polyurethane foam/<br>high resilient foam         |
| 2 | upholstery belts                                  |
| 3 | FSC® certified wood<br>and wood based<br>elements |
| 4 | fabric  |
| 5 | FSC® certified solid<br>wood legs                 |

### COMFORT: lux

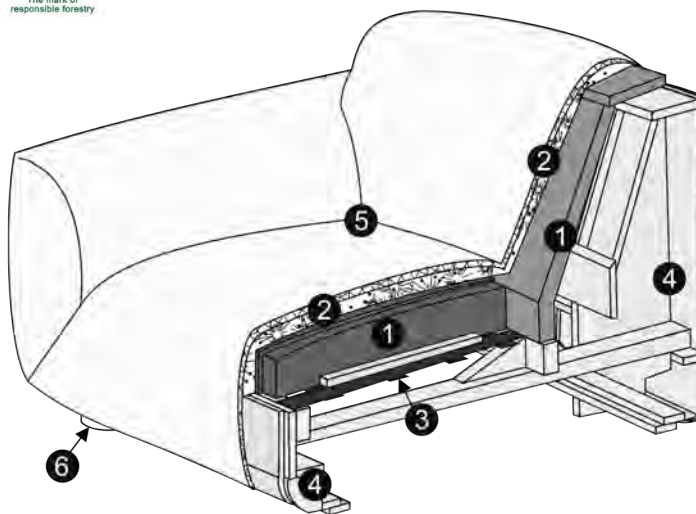

- |   |  |
|---|--|
| 1 | polyurethane<br>foam/high resilient<br>polyurethane foam     |
| 2 | cushion chamber with<br>mix of feather and<br>silicone balls |
| 3 | upholstery belts   |
| 4 | FSC® certified wood<br>and wood based<br>elements            |
| 5 | fabric   |
| 6 | FSC® certified solid<br>wood legs                            |

The producer reserves the right to change construction of products and components used due to improving durability of product and customer satisfaction without any further notice.

# EMILY

## TECHNICAL SPECIFICATION

### UPHOLSTERY:

fabric: LCV - loose cover with velcro    comfort: standard

### FEET

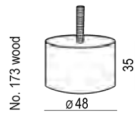

### COLOURS OF WOODEN FEET

oak



bleached  
oak



walnut



black



## Pricelist 2026

UPHOLSTERY: fabric: LCV - loose cover with velcro  
COMFORTS: STD - standard, LUX - lux

Currency: EUR valid from: 01.04.2026

DIMENSION*	DESCRIPTION ARTICLE No	VOL.	WEIGHT	FABRIC USAGE	A	I	II	III	IV	E
------------	---------------------------	------	--------	-----------------	---	---	----	-----	----	---

### freestanding elements for building sets :

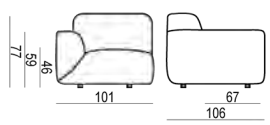
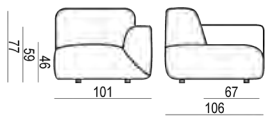
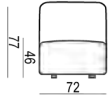
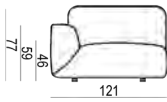
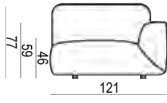
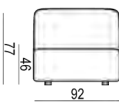
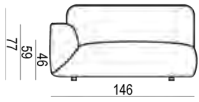
<b>101x106x77/46</b>		<b>armchair left</b>									
	STD	<b>E1711-0020-4S</b>	0,87	47	5,4	<b>1 644</b>	<b>1 644</b>	<b>1 747</b>	<b>1 851</b>	<b>1 940</b>	<b>2 428</b>
	LUX	<b>E1711-0020-4L</b>	0,87	47	5,4	<b>1 644</b>	<b>1 644</b>	<b>1 747</b>	<b>1 851</b>	<b>1 940</b>	<b>2 428</b>
	COVER	<b>E0711-0020-4</b>	0,04	4	5,4	<b>829</b>	<b>818</b>	<b>930</b>	<b>1 025</b>	<b>1 114</b>	<b>1 602</b>
<b>101x106x77/46</b>		<b>armchair right</b>									
	STD	<b>E1711-0010-4S</b>	0,87	47	5,4	<b>1 644</b>	<b>1 644</b>	<b>1 747</b>	<b>1 851</b>	<b>1 940</b>	<b>2 428</b>
	LUX	<b>E1711-0010-4L</b>	0,87	47	5,4	<b>1 644</b>	<b>1 644</b>	<b>1 747</b>	<b>1 851</b>	<b>1 940</b>	<b>2 428</b>
	COVER	<b>E0711-0010-4</b>	0,04	4	5,4	<b>829</b>	<b>818</b>	<b>930</b>	<b>1 025</b>	<b>1 114</b>	<b>1 602</b>
<b>72x106x77/46</b>		<b>armchair without armrests</b>									
	STD	<b>E1711-0030-4S</b>	0,60	35	3,9	<b>1 358</b>	<b>1 358</b>	<b>1 431</b>	<b>1 504</b>	<b>1 568</b>	<b>1 960</b>
	LUX	<b>E1711-0030-4L</b>	0,60	35	3,9	<b>1 358</b>	<b>1 358</b>	<b>1 431</b>	<b>1 504</b>	<b>1 568</b>	<b>1 960</b>
	COVER	<b>E0711-0030-4</b>	0,03	3	3,9	<b>689</b>	<b>669</b>	<b>762</b>	<b>818</b>	<b>879</b>	<b>1 271</b>
<b>121x106x77/46</b>		<b>armchair wide left</b>									
	STD	<b>E1711-0120-4S</b>	1,04	57	6,1	<b>1 870</b>	<b>1 870</b>	<b>1 996</b>	<b>2 106</b>	<b>2 215</b>	<b>2 769</b>
	LUX	<b>E1711-0120-4L</b>	1,04	57	6,1	<b>1 870</b>	<b>1 870</b>	<b>1 996</b>	<b>2 106</b>	<b>2 215</b>	<b>2 769</b>
	COVER	<b>E0711-0120-4</b>	0,04	4	6,1	<b>935</b>	<b>935</b>	<b>1 064</b>	<b>1 170</b>	<b>1 280</b>	<b>1 834</b>
<b>121x106x77/46</b>		<b>armchair wide right</b>									
	STD	<b>E1711-0110-4S</b>	1,04	57	6,1	<b>1 870</b>	<b>1 870</b>	<b>1 996</b>	<b>2 106</b>	<b>2 215</b>	<b>2 769</b>
	LUX	<b>E1711-0110-4L</b>	1,04	57	6,1	<b>1 870</b>	<b>1 870</b>	<b>1 996</b>	<b>2 106</b>	<b>2 215</b>	<b>2 769</b>
	COVER	<b>E0711-0110-4</b>	0,04	4	6,1	<b>935</b>	<b>935</b>	<b>1 064</b>	<b>1 170</b>	<b>1 280</b>	<b>1 834</b>
<b>92x106x77/46</b>		<b>armchair wide without armrests</b>									
	STD	<b>E1711-0130-4S</b>	0,77	43	4,7	<b>1 546</b>	<b>1 546</b>	<b>1 638</b>	<b>1 716</b>	<b>1 795</b>	<b>2 243</b>
	LUX	<b>E1711-0130-4L</b>	0,77	43	4,7	<b>1 546</b>	<b>1 546</b>	<b>1 638</b>	<b>1 716</b>	<b>1 795</b>	<b>2 243</b>
	COVER	<b>E0711-0130-4</b>	0,03	3	4,7	<b>781</b>	<b>764</b>	<b>874</b>	<b>935</b>	<b>1 016</b>	<b>1 462</b>
<b>146x106x77/46</b>		<b>2 seater left</b>									
	STD	<b>E1711-0220-4S</b>	1,24	69	6,9	<b>2 013</b>	<b>2 013</b>	<b>2 145</b>	<b>2 274</b>	<b>2 388</b>	<b>2 985</b>
	LUX	<b>E1711-0220-4L</b>	1,24	69	6,9	<b>2 013</b>	<b>2 013</b>	<b>2 145</b>	<b>2 274</b>	<b>2 388</b>	<b>2 985</b>
	COVER	<b>E0711-0220-4</b>	0,04	5	6,9	<b>1 016</b>	<b>1 000</b>	<b>1 148</b>	<b>1 263</b>	<b>1 378</b>	<b>1 974</b>

## Pricelist 2026

UPHOLSTERY: fabric: LCV - loose cover with velcro  
COMFORTS: STD - standard, LUX - lux

Currency: EUR valid from: 01.04.2026

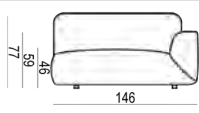
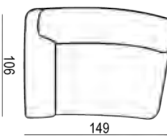
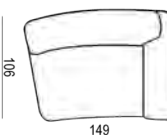
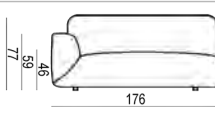
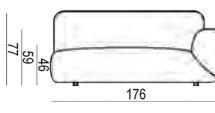
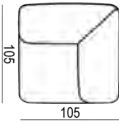
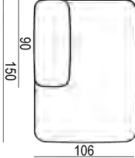
DIMENSION*	DESCRIPTION ARTICLE No	VOL.	WEIGHT	FABRIC USAGE	A	I	II	III	IV	E	
	<b>2 seater right</b>										
	STD	<b>E1711-0210-4S</b>	1,24	69	6,9	<b>2 013</b>	<b>2 013</b>	<b>2 145</b>	<b>2 274</b>	<b>2 388</b>	<b>2 985</b>
	LUX	<b>E1711-0210-4L</b>	1,24	69	6,9	<b>2 013</b>	<b>2 013</b>	<b>2 145</b>	<b>2 274</b>	<b>2 388</b>	<b>2 985</b>
	COVER	<b>E0711-0210-4</b>	0,04	5	6,9	<b>1 016</b>	<b>1 000</b>	<b>1 148</b>	<b>1 263</b>	<b>1 378</b>	<b>1 974</b>
	<b>2 seater round left</b>										
	STD	<b>E1711-0214-4S</b>	1,43	78	6,0	<b>2 114</b>	<b>2 114</b>	<b>2 229</b>	<b>2 346</b>	<b>2 442</b>	<b>3 052</b>
	LUX	<b>E1711-0214-4L</b>	1,43	78	6,0	<b>2 114</b>	<b>2 114</b>	<b>2 229</b>	<b>2 346</b>	<b>2 442</b>	<b>3 052</b>
	COVER	<b>E0711-0214-4</b>	0,04	4	6,0	<b>1 064</b>	<b>1 056</b>	<b>1 176</b>	<b>1 285</b>	<b>1 383</b>	<b>1 994</b>
	<b>2 seater round right</b>										
	STD	<b>E1711-0213-4S</b>	1,43	78	6,0	<b>2 114</b>	<b>2 114</b>	<b>2 229</b>	<b>2 346</b>	<b>2 442</b>	<b>3 052</b>
	LUX	<b>E1711-0213-4L</b>	1,43	78	6,0	<b>2 114</b>	<b>2 114</b>	<b>2 229</b>	<b>2 346</b>	<b>2 442</b>	<b>3 052</b>
	COVER	<b>E0711-0213-4</b>	0,04	4	6,0	<b>1 064</b>	<b>1 056</b>	<b>1 176</b>	<b>1 285</b>	<b>1 383</b>	<b>1 994</b>
	<b>2,5 seater left</b>										
	STD	<b>E1711-0320-4S</b>	1,49	82	7,9	<b>2 419</b>	<b>2 419</b>	<b>2 559</b>	<b>2 682</b>	<b>2 792</b>	<b>3 480</b>
	LUX	<b>E1711-0320-4L</b>	1,49	82	7,9	<b>2 419</b>	<b>2 419</b>	<b>2 559</b>	<b>2 682</b>	<b>2 792</b>	<b>3 480</b>
	COVER	<b>E0711-0320-4</b>	0,04	5	7,9	<b>1 218</b>	<b>1 204</b>	<b>1 361</b>	<b>1 467</b>	<b>1 576</b>	<b>2 265</b>
	<b>2,5 seater right</b>										
	STD	<b>E1711-0310-4S</b>	1,49	82	7,9	<b>2 419</b>	<b>2 419</b>	<b>2 559</b>	<b>2 682</b>	<b>2 792</b>	<b>3 480</b>
	LUX	<b>E1711-0310-4L</b>	1,49	82	7,9	<b>2 419</b>	<b>2 419</b>	<b>2 559</b>	<b>2 682</b>	<b>2 792</b>	<b>3 480</b>
	COVER	<b>E0711-0310-4</b>	0,04	5	7,9	<b>1 218</b>	<b>1 204</b>	<b>1 361</b>	<b>1 467</b>	<b>1 576</b>	<b>2 265</b>
	<b>corner 90</b>										
	STD	<b>E1711-1302-4S</b>	0,90	50	5,7	<b>1 700</b>	<b>1 700</b>	<b>1 809</b>	<b>1 918</b>	<b>2 013</b>	<b>2 514</b>
	LUX	<b>E1711-1302-4L</b>	0,90	50	5,7	<b>1 700</b>	<b>1 700</b>	<b>1 809</b>	<b>1 918</b>	<b>2 013</b>	<b>2 514</b>
	COVER	<b>E0711-1302-4</b>	0,04	4	5,7	<b>860</b>	<b>846</b>	<b>969</b>	<b>1 064</b>	<b>1 156</b>	<b>1 660</b>
	<b>bench left</b>										
	STD	<b>E1711-1310-4S</b>	1,28	71	5,5	<b>1 887</b>	<b>1 887</b>	<b>1 991</b>	<b>2 094</b>	<b>2 184</b>	<b>2 730</b>
	LUX	<b>E1711-1310-4L</b>	1,28	71	5,5	<b>1 887</b>	<b>1 887</b>	<b>1 991</b>	<b>2 094</b>	<b>2 184</b>	<b>2 730</b>
	COVER	<b>E0711-1310-4</b>	0,04	4	5,5	<b>955</b>	<b>932</b>	<b>1 058</b>	<b>1 142</b>	<b>1 232</b>	<b>1 781</b>

## Pricelist 2026

UPHOLSTERY: fabric: LCV - loose cover with velcro  
COMFORTS: STD - standard, LUX - lux

Currency: EUR valid from: 01.04.2026

DIMENSION*	DESCRIPTION ARTICLE No	VOL.	WEIGHT	FABRIC USAGE	A	I	II	III	IV	E	
	<b>bench right</b>										
	STD	<b>E1711-1311-4S</b>	1,28	71	5,5	<b>1 887</b>	<b>1 887</b>	<b>1 991</b>	<b>2 094</b>	<b>2 184</b>	<b>2 730</b>
	LUX	<b>E1711-1311-4L</b>	1,28	71	5,5	<b>1 887</b>	<b>1 887</b>	<b>1 991</b>	<b>2 094</b>	<b>2 184</b>	<b>2 730</b>
	COVER	<b>E0711-1311-4</b>	0,04	4	5,5	<b>955</b>	<b>932</b>	<b>1 058</b>	<b>1 142</b>	<b>1 232</b>	<b>1 781</b>
	<b>bench round left</b>										
	STD	<b>E1711-2310-4S</b>	1,23	78	5,2	<b>1 980</b>	<b>1 982</b>	<b>2 092</b>	<b>2 201</b>	<b>2 293</b>	<b>2 864</b>
	LUX	<b>E1711-2310-4L</b>	1,23	78	5,2	<b>1 982</b>	<b>1 982</b>	<b>2 092</b>	<b>2 201</b>	<b>2 293</b>	<b>2 864</b>
	COVER	<b>E0711-2310-4</b>	0,04	4	5,2	<b>1 000</b>	<b>983</b>	<b>1 109</b>	<b>1 204</b>	<b>1 294</b>	<b>1 868</b>
	<b>bench round right</b>										
	STD	<b>E1711-2311-4S</b>	1,23	78	5,2	<b>1 980</b>	<b>1 982</b>	<b>2 092</b>	<b>2 201</b>	<b>2 293</b>	<b>2 864</b>
	LUX	<b>E1711-2311-4L</b>	1,23	78	5,2	<b>1 982</b>	<b>1 982</b>	<b>2 092</b>	<b>2 201</b>	<b>2 293</b>	<b>2 864</b>
	COVER	<b>E0711-2311-4</b>	0,04	4	5,2	<b>1 000</b>	<b>983</b>	<b>1 109</b>	<b>1 204</b>	<b>1 294</b>	<b>1 868</b>
	<b>bench round large left</b>										
	STD	<b>E1711-2314-4S</b>	2,65	91	7,5	<b>2 534</b>	<b>2 534</b>	<b>2 677</b>	<b>2 822</b>	<b>2 946</b>	<b>3 679</b>
	LUX	<b>E1711-2314-4L</b>	2,65	91	7,5	<b>2 534</b>	<b>2 534</b>	<b>2 677</b>	<b>2 822</b>	<b>2 946</b>	<b>3 679</b>
	COVER	<b>E0711-2314-4</b>	0,04	5	7,5	<b>1 280</b>	<b>1 257</b>	<b>1 425</b>	<b>1 546</b>	<b>1 669</b>	<b>2 402</b>
	<b>bench round large right</b>										
	STD	<b>E1711-2315-4S</b>	2,65	91	7,5	<b>2 534</b>	<b>2 534</b>	<b>2 677</b>	<b>2 822</b>	<b>2 946</b>	<b>3 679</b>
	LUX	<b>E1711-2315-4L</b>	2,65	91	7,5	<b>2 534</b>	<b>2 534</b>	<b>2 677</b>	<b>2 822</b>	<b>2 946</b>	<b>3 679</b>
	COVER	<b>E0711-2315-4</b>	0,04	5	7,5	<b>1 280</b>	<b>1 257</b>	<b>1 425</b>	<b>1 546</b>	<b>1 669</b>	<b>2 402</b>

## Pricelist 2026

UPHOLSTERY: fabric: LCV - loose cover with velcro  
COMFORTS: STD - standard, LUX - lux

Currency: EUR valid from: 01.04.2026

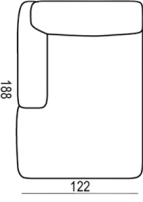
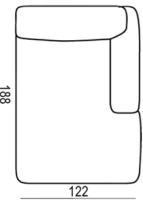
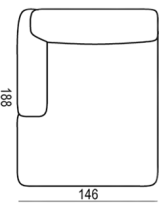
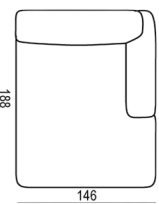
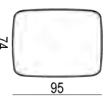
DIMENSION*	DESCRIPTION ARTICLE No	VOL.	WEIGHT	FABRIC USAGE	A	I	II	III	IV	E	
122x188x77/46	<b>chaiselongue left</b>										
	STD	<b>E1711-1200-4S</b>	1,79	65	7,2	<b>2 439</b>	<b>2 439</b>	<b>2 576</b>	<b>2 716</b>	<b>2 834</b>	<b>3 542</b>
	LUX	<b>E1711-1200-4L</b>	1,79	65	7,2	<b>2 439</b>	<b>2 439</b>	<b>2 576</b>	<b>2 716</b>	<b>2 834</b>	<b>3 542</b>
	COVER	<b>E0711-1200-4</b>	0,04	5	7,2	<b>1 232</b>	<b>1 210</b>	<b>1 372</b>	<b>1 484</b>	<b>1 602</b>	<b>2 310</b>
122x188x77/46	<b>chaiselongue right</b>										
	STD	<b>E1711-1210-4S</b>	1,79	65	7,2	<b>2 439</b>	<b>2 439</b>	<b>2 576</b>	<b>2 716</b>	<b>2 834</b>	<b>3 542</b>
	LUX	<b>E1711-1210-4L</b>	1,79	65	7,2	<b>2 439</b>	<b>2 439</b>	<b>2 576</b>	<b>2 716</b>	<b>2 834</b>	<b>3 542</b>
	COVER	<b>E0711-1210-4</b>	0,04	5	7,2	<b>1 232</b>	<b>1 210</b>	<b>1 372</b>	<b>1 484</b>	<b>1 602</b>	<b>2 310</b>
146x188x77/46	<b>chaiselongue wide left</b>										
	STD	<b>E1711-1201-4S</b>	2,15	79	8,2	<b>2 674</b>	<b>2 674</b>	<b>2 831</b>	<b>2 988</b>	<b>3 125</b>	<b>3 903</b>
	LUX	<b>E1711-1201-4L</b>	2,15	79	8,2	<b>2 674</b>	<b>2 674</b>	<b>2 831</b>	<b>2 988</b>	<b>3 125</b>	<b>3 903</b>
	COVER	<b>E0711-1201-4</b>	0,04	5	8,2	<b>1 341</b>	<b>1 333</b>	<b>1 498</b>	<b>1 646</b>	<b>1 784</b>	<b>2 562</b>
146x188x77/46	<b>chaiselongue wide right</b>										
	STD	<b>E1711-1211-4S</b>	2,15	79	8,2	<b>2 674</b>	<b>2 674</b>	<b>2 831</b>	<b>2 988</b>	<b>3 125</b>	<b>3 903</b>
	LUX	<b>E1711-1211-4L</b>	2,15	79	8,2	<b>2 674</b>	<b>2 674</b>	<b>2 831</b>	<b>2 988</b>	<b>3 125</b>	<b>3 903</b>
	COVER	<b>E0711-1211-4</b>	0,04	5	8,2	<b>1 341</b>	<b>1 333</b>	<b>1 498</b>	<b>1 646</b>	<b>1 784</b>	<b>2 562</b>
95x74/46	<b>footstool 95x74</b>										
	STD	<b>E1711-1050-4S</b>	0,31	16	3,1	<b>812</b>	<b>812</b>	<b>874</b>	<b>935</b>	<b>983</b>	<b>1 229</b>
	LUX	<b>E1711-1050-4L</b>	0,31	16	3,1	<b>812</b>	<b>812</b>	<b>874</b>	<b>935</b>	<b>983</b>	<b>1 229</b>
	COVER	<b>E0711-1050-4</b>	0,03	3	3,1	<b>406</b>	<b>406</b>	<b>468</b>	<b>535</b>	<b>580</b>	<b>823</b>

## Pricelist 2026

UPHOLSTERY: fabric: LCV - loose cover with velcro  
COMFORTS: STD - standard, LUX - lux

Currency: EUR valid from: 01.04.2026

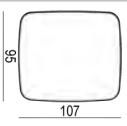
DIMENSION*	DESCRIPTION ARTICLE No	VOL.	WEIGHT	FABRIC USAGE	A	I	II	III	IV	E	
107x95/46	<b>footstool 107x95</b>										
	STD	<b>E1711-1060-4S</b>	0,44	20	3,5	<b>946</b>	<b>946</b>	<b>1 014</b>	<b>1 078</b>	<b>1 134</b>	<b>1 417</b>
	LUX	<b>E1711-1060-4L</b>	0,44	20	3,5	<b>946</b>	<b>946</b>	<b>1 014</b>	<b>1 078</b>	<b>1 134</b>	<b>1 417</b>
	COVER	<b>E0711-1060-4</b>	0,03	3	3,5	<b>487</b>	<b>459</b>	<b>554</b>	<b>596</b>	<b>652</b>	<b>932</b>

### suggested sets:

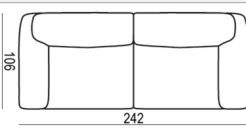
242x106x77/46	<b>SET.1 - armchair wide left + armchair wide right</b>										
	STD	<b>E1711-5122-4S</b>	2,07	114	12,2	<b>3 741</b>	<b>3 741</b>	<b>3 990</b>	<b>4 208</b>	<b>4 430</b>	<b>5 536</b>
	LUX	<b>E1711-5122-4L</b>	2,07	114	12,2	<b>3 741</b>	<b>3 741</b>	<b>3 990</b>	<b>4 208</b>	<b>4 430</b>	<b>5 536</b>
	COVER	<b>E0711-5122-4</b>	0,08	8	12,2	<b>1 870</b>	<b>1 870</b>	<b>2 122</b>	<b>2 338</b>	<b>2 559</b>	<b>3 665</b>

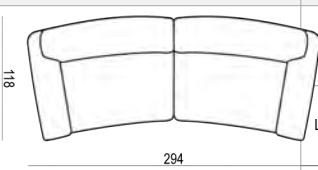
294x118x77/46	<b>SET.2 - 2 seater round left + 2 seater round right</b>										
	STD	<b>E1711-5220-4S</b>	2,86	155	13,8	<b>4 228</b>	<b>4 228</b>	<b>4 458</b>	<b>4 690</b>	<b>4 880</b>	<b>6 101</b>
	LUX	<b>E1711-5220-4L</b>	2,86	155	13,8	<b>4 228</b>	<b>4 228</b>	<b>4 458</b>	<b>4 690</b>	<b>4 880</b>	<b>6 101</b>
	COVER	<b>E0711-5220-4</b>	0,08	8	13,8	<b>2 122</b>	<b>2 108</b>	<b>2 352</b>	<b>2 570</b>	<b>2 764</b>	<b>3 984</b>

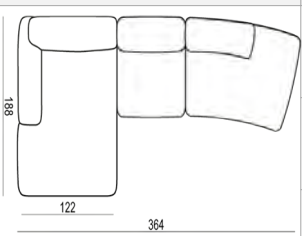
364x118/188x77/46	<b>SET.3 left - chaiselongue left + armchair wide without armrests + bench round right</b>										
	STD	<b>E1711-5028-4S</b>	3,80	186	17,1	<b>5 958</b>	<b>5 961</b>	<b>6 303</b>	<b>6 625</b>	<b>6 916</b>	<b>8 641</b>
	LUX	<b>E1711-5028-4L</b>	3,80	186	17,1	<b>5 961</b>	<b>5 961</b>	<b>6 303</b>	<b>6 625</b>	<b>6 916</b>	<b>8 641</b>
	COVER	<b>E0711-5028-4</b>	0,11	12	17,1	<b>3 010</b>	<b>2 954</b>	<b>3 349</b>	<b>3 618</b>	<b>3 909</b>	<b>5 634</b>

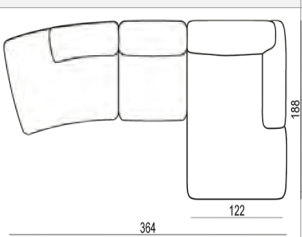
364x118/188x77/46	<b>SET.3 right - chaiselongue right + armchair wide without armrests + bench round left</b>										
	STD	<b>E1711-5029-4S</b>	3,80	186	17,1	<b>5 958</b>	<b>5 961</b>	<b>6 303</b>	<b>6 625</b>	<b>6 916</b>	<b>8 641</b>
	LUX	<b>E1711-5029-4L</b>	3,80	186	17,1	<b>5 961</b>	<b>5 961</b>	<b>6 303</b>	<b>6 625</b>	<b>6 916</b>	<b>8 641</b>
	COVER	<b>E0711-5029-4</b>	0,11	12	17,1	<b>3 010</b>	<b>2 954</b>	<b>3 349</b>	<b>3 618</b>	<b>3 909</b>	<b>5 634</b>

## Pricelist 2026

UPHOLSTERY: fabric: LCV - loose cover with velcro  
COMFORTS: STD - standard, LUX - lux

Currency: EUR valid from: 01.04.2026

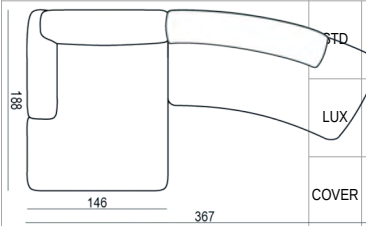
DIMENSION*	DESCRIPTION ARTICLE No	VOL.	WEIGHT	FABRIC USAGE	A	I	II	III	IV	E	
367x145/188x77/46	<b>SET.4 left - chaiselongue wide left + bench round large right</b>										
	STD	<b>E1711-5920-4S</b>	4,80	170	14,7	5 205	5 205	5 502	5 807	6 065	7 580
	LUX	<b>E1711-5920-4L</b>	4,80	170	14,7	5 205	5 205	5 502	5 807	6 065	7 580
	COVER	<b>E0711-5920-4</b>	0,08	9	14,7	2 621	2 584	2 920	3 192	3 447	4 962

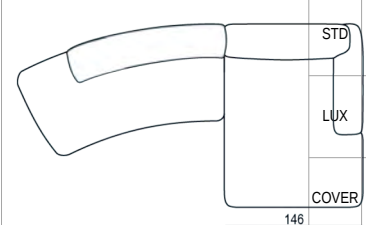
367x145/188x77/46	<b>SET.4 right - chaiselongue wide right + bench round large left</b>										
	STD	<b>E1711-5921-4S</b>	4,80	170	14,7	5 205	5 205	5 502	5 807	6 065	7 580
	LUX	<b>E1711-5921-4L</b>	4,80	170	14,7	5 205	5 205	5 502	5 807	6 065	7 580
	COVER	<b>E0711-5921-4</b>	0,08	9	14,7	2 621	2 584	2 920	3 192	3 447	4 962

**\*Explicit +/- 2 cm tolerance of all elements sizes**

Załączone ceny rekomendowane mają charakter sugerowanych cen sprzedaży. Kupujący nie jest związany cenami rekomendowanymi.